

ERGO

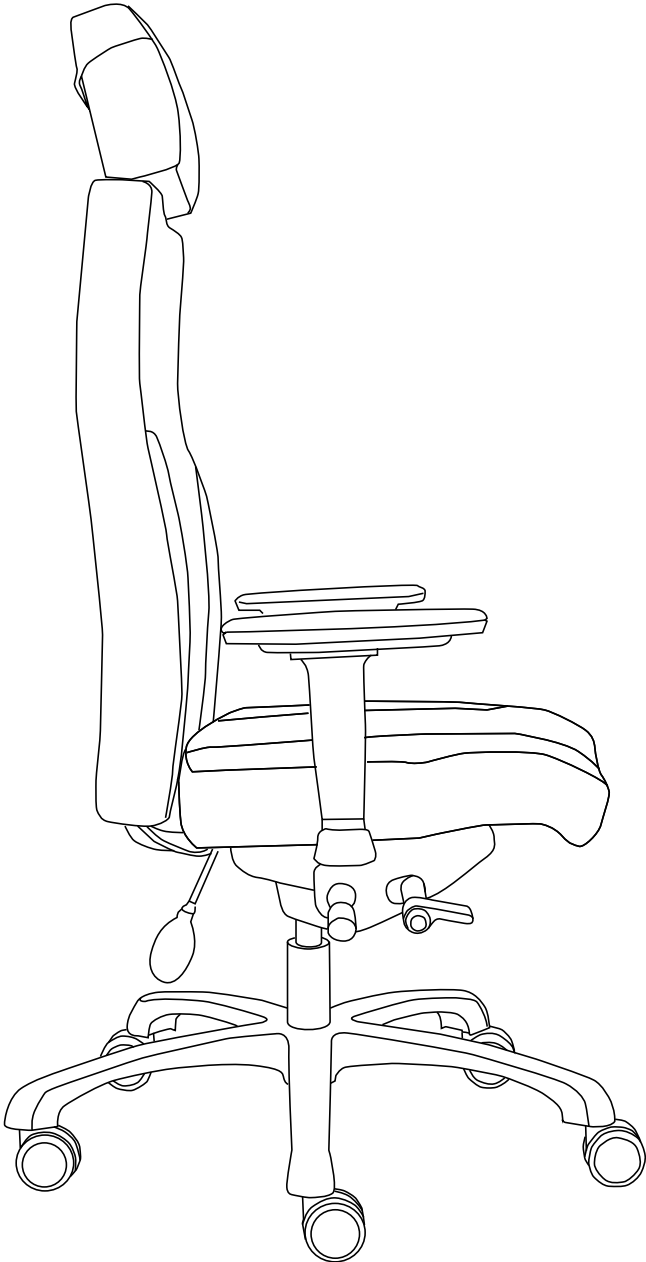

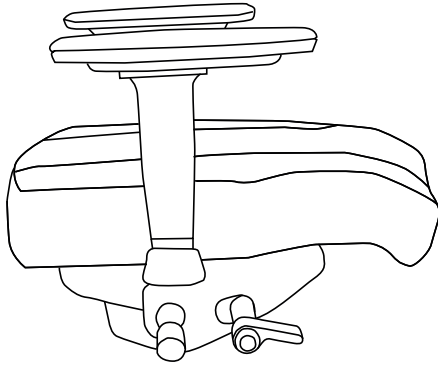

1x



1x

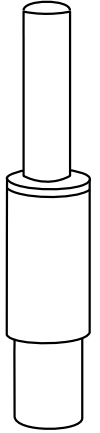

1x

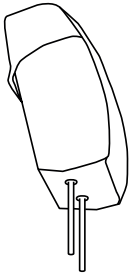

1x

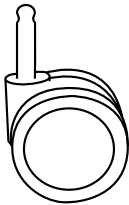

5x

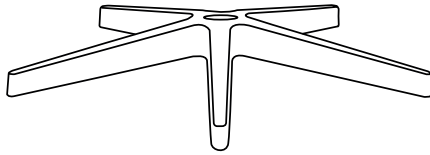

1x

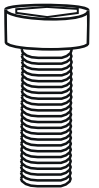

3x

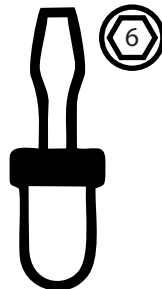
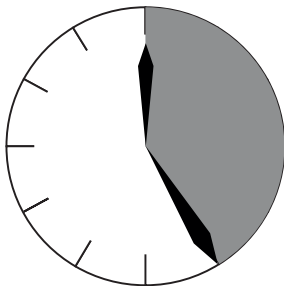

1.

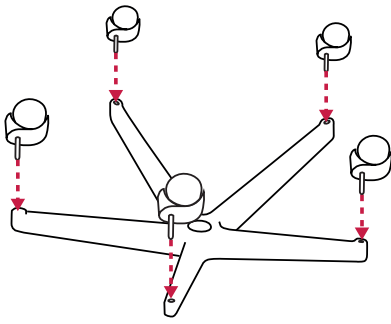

2.

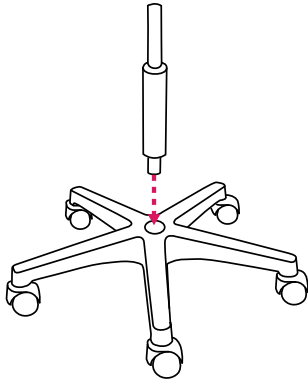

3.

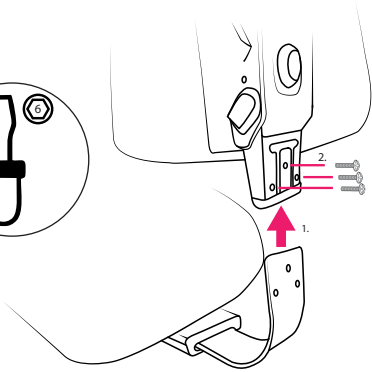

4.

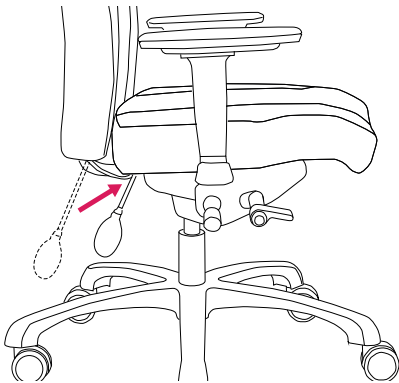

5.

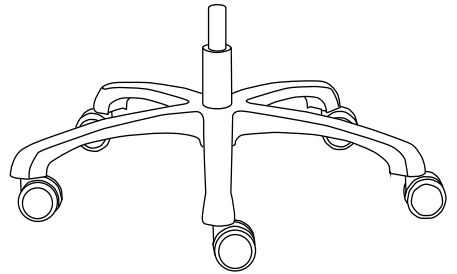
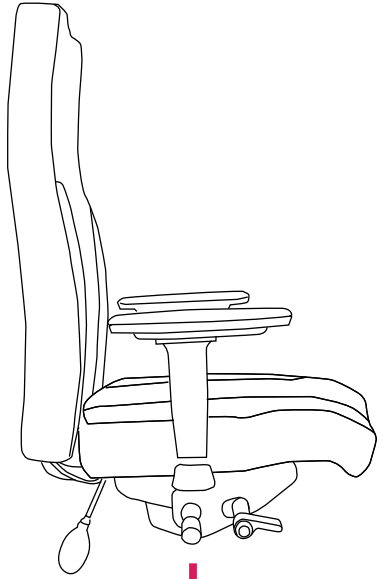

6.



